

Regolatori agricoltura / Regulators for agriculture

# Gruppo regolazione Multicontrol Multicontrol Regulating Unit



200 l/m  
52.8 USGPM



max 20 BAR  
290 P.S.I.

## APPLICAZIONI - APPLICATIONS



AGRICOLTURA  
AGRICULTURE



SPRAYER  
SPRAYER



DISINFESTAZIONE  
DISINFESTATION



ATOMIZZATORI  
ATOMIZERS

Gruppi MULTICONTROL con valvola di regolazione massima pressione a membrana e valvola generale di chiusura mandate a sfera.  
*MULTICONTROL units supplied with diaphragm pressure relief valve and main valve offering shut-off function.*



VPBP	⊗ (N° 2 RS)	Cod. Part Number
<b>GRUPPI AD AZIONAMENTO ELETTRICO MOTOR-POWERED UNITS</b>		
5 Sec.		25.8451.97.3T5
	2RS (OUT D.16)	25.8452.97.3T5
9 Sec.		25.8142.97.3T5
	2RS (OUT D.16)	25.8453.97.3T5
21 Sec.		25.8454.97.3T5
	2RS (OUT D.16)	25.8455.97.3T5
⊗ A	VG 5 sec. 0.6A - VG 5 sec. 0.6A VPBP 5-9 sec. per computer 0.2A - VPBP 5-9 sec. for computers 0.2A VPBP 21 sec. per pannelli di comando 0.2A - VPBP 21 sec. for sprayer controls 0.2A	

Dimensioni raccordi Pipe fittings				
IN	OUT	By-pass		
G. 1"	T5	VS	VG	VPBP
		G. 1" 1/4		Ptg. D. 25 mm Hosetails dia.25 mm



Regolatori agricoltura / Regulators for agriculture

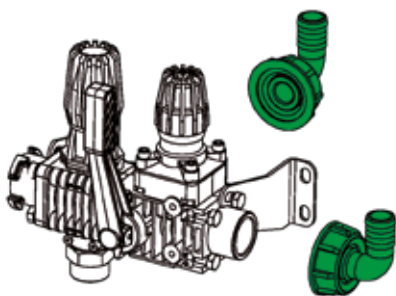
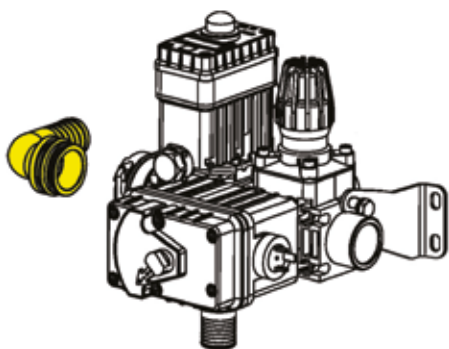

## Gruppo regolazione Multicontrol Multicontrol Regulating Unit

	200 l/m 52.8 USGPM		max 20 BAR 290 P.S.I.
---	-----------------------	---	--------------------------

RACCORDI / THREADED FITTING



	Mod.	Serie 5 M
25		25.3060.97.3T5
30		25.3061.97.3T5
32		25.3062.97.3T5

		Cod. Part Number
25 mm 90° (1")	19 mm (3/4")	25.1925.97.3
	19 mm (3/4") 90°	25.1926.97.3
	25 mm (1")	25.2525.97.3
	25 mm (1") 90°	25.2526.97.3
30 mm 1" 3/16 90°	25 mm (1")	25.2530.97.3
	25 mm (1") 90°	25.2531.97.3







VALVOLE / THREADED FITTING

VALVOLE DI REGOLAZIONE PRESSIONE PROPORZIONALE - PROPORTIONAL PRESSURE REGULATING VALVES

Valvola di regolazione pressione proporzionale a otturatore sagomato e sede in acciaio inox AISI 316.

*Proportional pressure valve (volumetric) with shaped poppet and seat made of AISI 316 stainless steel.*



Mod.	Colore Color			Max 				A		Cod. Part Number
		Bar	PSI	L/min.	USGPM					
VPBPE		20	290	160	42	GAS 10"	12VDC±2	0.2	9	25.8652.97.3

VPBPE

# Gruppo regolazione Multicontrol Multicontrol Regulating Unit

	200 l/m 52.8 USGPM		max 20 BAR 290 P.S.I.
---	-----------------------	---	--------------------------

## VARIANTI / MODELS

Distributori MULTICONTROL completi con valvola di regolazione massima pressione a membrana, valvola generale di chiusura mandate a sfera, valvola di regolazione proporzionale e valvole di sezione con o senza ritorni registrabili.

MULTICONTROL units fitted with diaphragm pressure relief valve, main ball valve offering shut-off function, volumetric valve and section valves available with or without metered by-pass.

### VERSIONI MOTORIZZATE - MOTOR-POWERED VERSIONS



RS





RD

(Con By-Pass Calibrato - With Metered By-Pass)



Nr. 	Cod. Part Number	Nr. 	VPBPE	Cod. Part Number
3	25.8289.97.3	3		25.8337.97.3
4	25.8290.97.3	4	9 sec.	25.8338.97.3
5	25.8291.97.3	5		25.8339.97.3

Nr. 	VPBPE	Cod. Part Number
3		25.1505.97.B
4	/	25.1506.97.B
5		25.1507.97.B

Nr. 	VPBPE	Cod. Part Number
3		25.8134.97.A
4	9 sec.	25.8170.97.A
5		25.8171.97.A

### VERSIONI MANUALI - MANUAL VERSIONS

RS





RD

(Con By-Pass Calibrato - With Metered By-Pass)



Nr. 	Cod. Part Number
3	25.1400.97.3
4	25.1401.97.3
5	25.1402.97.3

Nr. 	VPBPE	Cod. Part Number
3		25.1410.97.B
4	/	25.1411.97.B
5		25.1412.97.B

Nr. 	Cod. Part Number
3	25.1405.97.A
4	25.1406.97.A
5	25.1407.97.A

## Esempio di gruppo compatto Multicontrol Regulating Unit example

Con (da destra) Valvola di Massima Pressione, Valvola Generale, Valvola Volumetrica e set valvole di sezione S5 motorizzate.

*Multicontrol Regulating Unit configuration: from right: maximum pressure relief valve, main on/off valve, regulating valve, motor-powered section valves*



### MODULARITÀ DI SISTEMA / MODULAR SYSTEM

POSSIBILITÀ DI COMPORRE IL GRUPPO A PIACERE  
SECONDO ESIGENZE E CARATTERISTICHE SPECIFICHE DEL CLIENTE.  
OPTION TO ASSEMBLE UNITS ACCORDING TO CUSTOMER NEEDS AND  
SPECIFIC FEATURES.

UNITÀ DI COMANDO componibili con attacchi "SERIE 5"  
MODULAR CONTROL UNITS WITH "SERIE 5" CONNECTIONS



Set valvole di sezione ad azionamento manuale o elettrico  
*Manual or motor powered section valves modules*

Accessori  
*Optionals extras*

Unità di regolazione ad azionamento  
manuale o elettrico  
*Manual or motor powered regulating  
units*

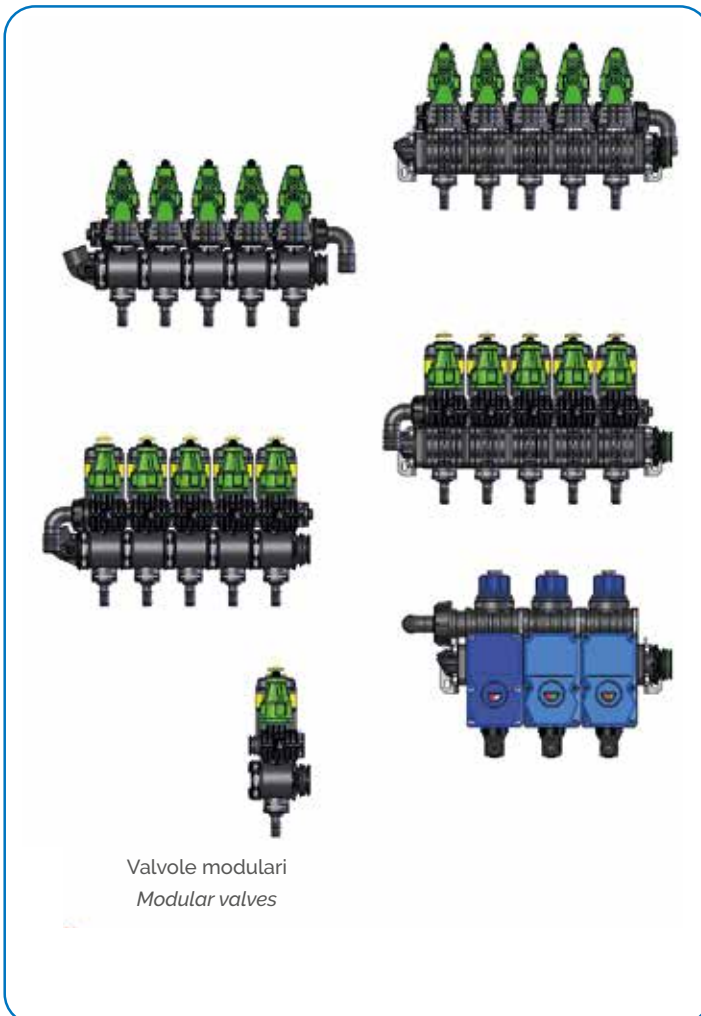

Valvole modulari  
*Modular valves*



Flussometri a turbina ed  
elettromagnetici  
*Turbine or  
electromagnetic flow  
meters*



Vedere sezione sito  
dedicata

Regolatori agricoltura / Regulators for agriculture

## Applicazioni "in campo"

### Traduzione

Il gruppo Multicontrol è idoneo all'installazione su qualunque tipologia di macchina, semovente trainata o portata, sia di piccole che grandi dimensioni,

*Ecocontrol Regulating Unit fits all self-propelled and trailed sprayers.*

